



therma**smart**® PRO

General Information

THERMAFLEX INSTALLATION MANUAL

DISCLAIMER:

The information in this document is based on our current state of technical knowledge. Due to the variety of possible influences during installation and combination of products, the insulator is responsible for any necessary verification of certain information. For the current technical product specifications, we refer to the relevant products and the related datasheets. Any copy, duplication or reprint requires a written agreement by Thermaflex International Holding bv.

Responsible publisher: Thermaflex International Holding bv

V2.0, 2020-02-11



Table of Contents

01. General	4
02. Design & preparation	6
03. Training for Professionals	10
04. Transport, storage & handling	10
05. Environment, health & safety	11
06. Installation	13
1. Installation conditions	13
2. Installation steps	14
3. Golden rules	16
4. Measurement & marking	17
5. Cutting	19
6. Cleaning & surface preparation	24
7. Gluing - ThermaGlue	25
07. Accessories	34
08. Tools	39

01. General

ThermaSmart PRO is a revolution in insulation, tackling all challenges of efficient and sustainable building design. Our full range of products offers a complete insulation solution for domestic hot, cold water, chilled water and refrigeration applications, securing safety, high performance and durability for decades to come.

This installation manual covers the general information for the installation of our ThermaSmart PRO systems for professional insulation. For instructions regarding specific application, please refer to the relevant installation manual.

Product range



ThermaSmart PRO Tubes



ThermaSmart PRO Sheet



Prefabricated Parts



Tools & Accessories

ThermaSmart PRO tubular insulation is available for carrier pipe diameters up to an 114mm. For larger tubes, ducts, vessel and tanks we offer ThermaSmart PRO sheet insulation.

Joining techniques

We offer two main joining techniques to seal off your system! These includes our long-time performance proven ThermaGlue as well as our heat plate tool for tubular prefabrications to simply and swiftly prefab-it-yourself, on site or in your workshop.

Glue



Heatplate

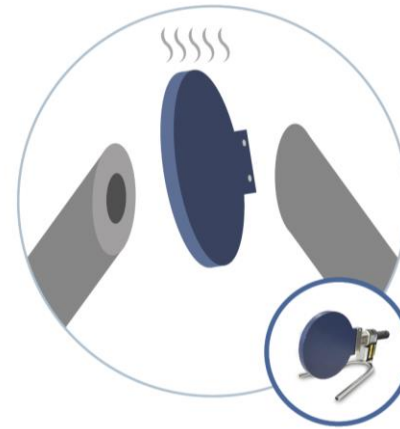

02. Design & preparation

Good design and preparation is 90% of success when it comes to high quality installation with high, secure and sustainable performance.

The right product

1. Insulation Calculator

Use our online “Insulation Calculator” to find the insulation thickness you need, and discover the future energy savings straight away!

Calculation tool

www.thermaflex.com/en/insulation-calculator

Important!

Regulations differ from country to country as well as between applications. Contact your local Thermaflex dealer for more information.

1.

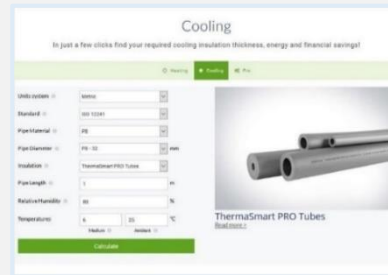

2. Select the right product

The right choice of products and sizes is essential for perfect-fit insulation in light of its tolerances. For technical specifications, measures and tolerances please refer to our technical product datasheets.

Right quantities

Don't forget allowance quantity for offcuts, compression joining as well as fitting insulation.

2.



TIP!



You can also contact your local insulation specialist to help you choose the right products, thicknesses, and quantities for your project.

Choose the method

How you deal with the on-site insulation of connections and fitting has a great influence on the speed and quality of installation.

For tubular insulation, we have the following options:

Rating:

-  Ease & time savings
-  Reliability
-  Health
-  Sustainability



Prefabrication with glue technology

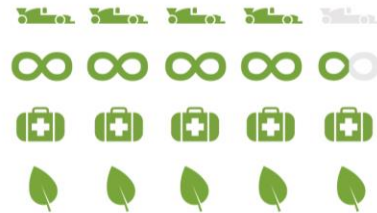
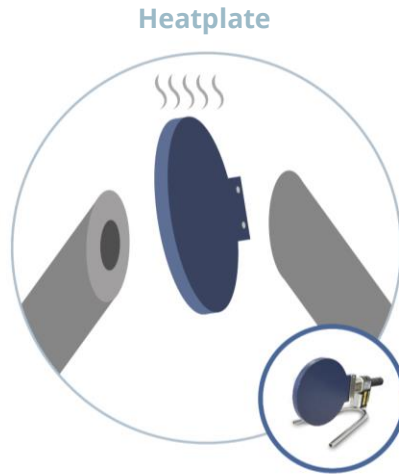

Prefabrication with polyfusion technology (heat plate)

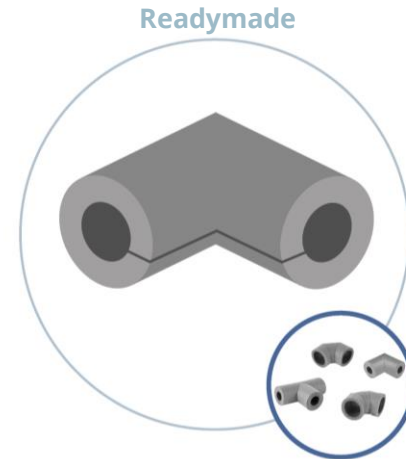

Ready-made prefabrication parts

3-001-01_F4

Pipe fixation

The choice of the pipe fixation system and the insulation thickness greatly affects the spacial design during the pipework installation. Bracket spacing depends on pipe system!

1. Thermaflex pipe hanger

Pre-insulated pipe hangers are installed together with the pipes. So designers / project planners must ensure selecting the right pipe hangers in the design process. That's the only way to guarantee that the right components are available on site for the pipework installation.

2. Ensure space between insulated pipes

When it comes to chilled water lines or refrigeration systems, space should be allowed between the insulated system components to ensure free convection. We recommend to use at least twice the insulation wall thickness as an additional safety measure against condensation.

t Wall thickness ThermaSmart Pro insulation material

Important!
For chilled water lines and refrigeration systems we recommend Thermaflex pipe hangers only to guarantee a vapor-tight insulated system without thermal bridges.

1.

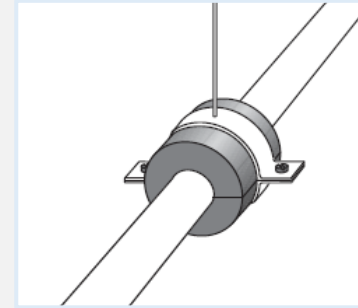

2.

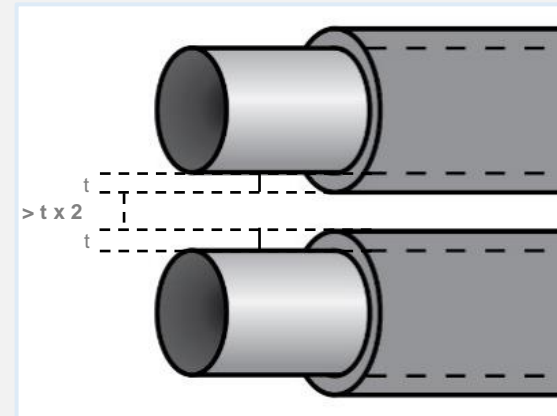

Outdoor application

ThermaSmart PRO insulation material is robust, resistant to mold and water vapor and absorption. In order to ensure this resistance in outdoor applications, when exposed to various weather conditions and ultraviolet radiation, we recommend applying a protective layer to the insulation.

1. Protective layer

The insulation material must be either painted, covered or cladded.

Cladding

In order to ensure a permanent resistance of ThermaSmart PRO to weather conditions and ultraviolet radiation, we recommend a cladding solution, such as aluminum cladding.

UV resistant paint

An easier, yet less permanent option is the use of a UV-resistant paint suitable for ThermaSmart PRO materials. In this case, the outdoor insulation system has to be inspected on a yearly base. Repainting is necessary depending on the environmental conditions.

For information regarding the number of layers and waiting times please refer to the label or technical datasheet. We recommend at least 2-3 layers, depending on the local climate, and a paint with an elasticity between 350-400%.

Important!

Apply paint only after using ThermaGlue, and leave at least 24 hours in between.

1.



Cladding



UV resistant paint

2. Place of installation

Outdoor, the insulation material must be protected against direct sunlight. Indoor, only take special care when installing behind windows as reflection and concentrated light can overheat the insulation.

Avoid strong reflection or magnifying conditions to prevent overheating of the material above the melting point.



Important!

Don't expose the connections of the ThermaSmart PRO insulation system to direct sunlight after joining!

2.



Outdoor



Indoor

03. Training for Professionals

PRO not only stands for professional materials, but also professional skills. Thermaflex offers trainings and qualifications for insulation professionals to ensure ease of handling and installation efficiency in upcoming projects.

Your benefits

- Become well equipped for Thermaflex projects
- Increase the quality of installation
- Investment in the insulation skill ranges of your employees



04. Transport, storage & handling

1. Transport

- Parcel service
- Truck transport
- Container transport
- ThermaGlue and Cleaner may require a MSDS and SDS.

Tip!

We are happy to help you with efficient packaging and loading. Just get in touch with your local Thermaflex office!

2. Handling

- Avoid direct sunlight on unpacked ThermaSmart PRO products.
- Do not wrap the insulation in foil. Only special UV-stable foil is suitable for ThermaSmart PRO.
- Open boxes at perforation and lay them down for easier material access.

1.



2.



2. Storage conditions

- Store on pallets
- Do not expose to sunlight and rain
- Store in a ventilated warehouse
- Do not store close to heat sources
- Keep clean
- Recommended storage temperature -20°C to +50°C
- Cardboard boxes – tubular insulation:
 - For longer periods, store in upright position.
- Sheet rolls:
 - Store the rolls in upright position. Avoid compressing of the lower layers.

Accessories:

- Respect datasheets and description on packaging.

2.



05. Environment, health and safety

Safety first!

Insulation works should only be performed by skilled professionals who have the required training, experience and knowledge of relevant regulations. Persons with the corresponding qualification should be informed about the job safety requirements and must have read and understood the installation manual before carrying out the assigned work.

The equipment used for the job must meet all local regulation, must be clean and fully functioning.

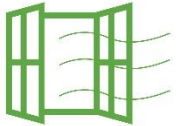

Ventilation

Make sure to have good ventilation when you are working with glue joining technology in confined spaces.



Safety regulations

Respect the relevant safety regulations for the workspace.



National laws

Make sure all tools used on site meet national regulations.



Certificate

Only instructed people should carry out installation works to avoid accidents.

Recommended workwear

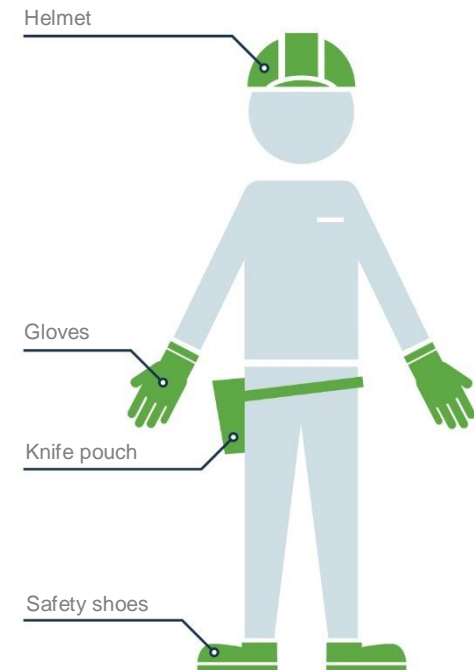

Taking care of energy and the environment

As the first Cradle to Cradle Certified™ technical insulation material, ThermaSmart PRO fully complies with our vision of a circular economy, and is 100% recyclable upon reclaim. This makes it an ideal solution for green building projects. You can check out a precise breakdown of ThermaSmart PRO for LEED and BREEAM specifications on our website as well as the Cradle to Cradle Certified™ Material Health Certificate and Environmental Product Declarations (EPD).

1. Reclaim

We believe in a circular economy. That's why in most countries we now have a Reclaim program, with the aim to close our product cycles, and eliminate waste wherever possible. Our specially designed ThermaSmartBox allows the repackaging of residual insulation waste, such as cut-offs, which will be fully recycled in our production process to serve its original purpose.

Not sure how it works? Find the instructions on [Youtube](#).



2. Save material

- Save glue by performing polyfusion welding for tube prefabrication - the most environmentally friendly and secure joining technique.
- Save glue for sheet insulation due to the stability of the product – no full surface bonding required for all diameters.
- Ready-made prefabricated parts.

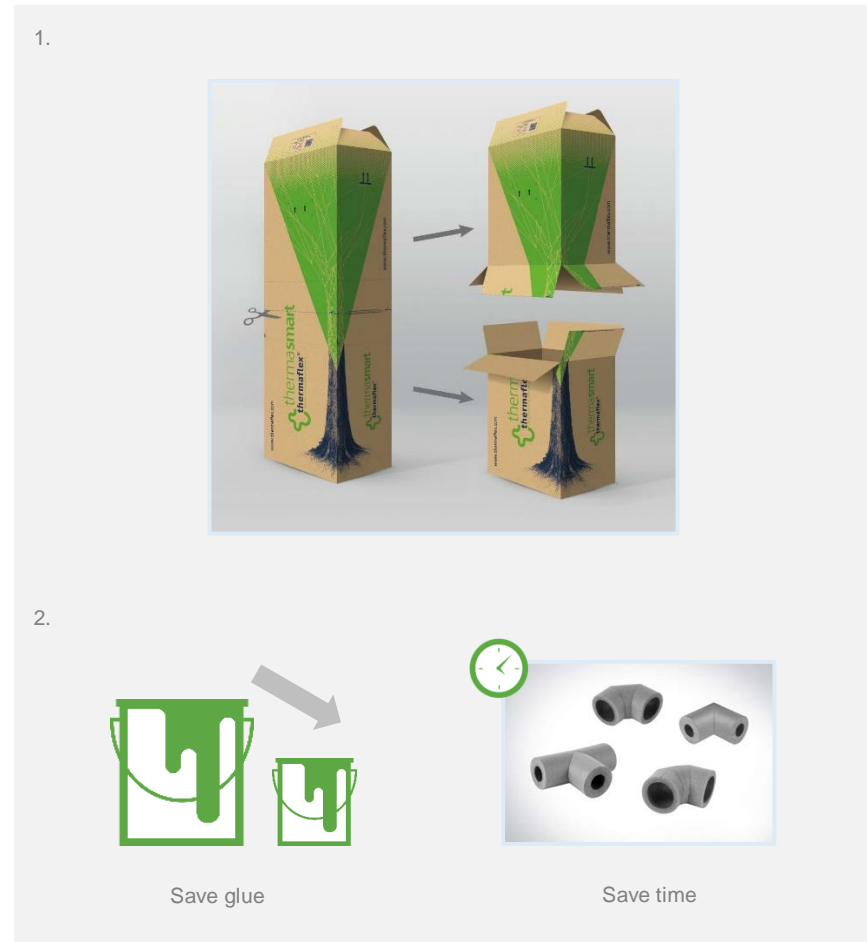

06. Installation

For a professional high-quality installation, the following installation conditions must be respected.

6.1. Installation conditions

Installation conditions



System decommissioned
System is decommissioned. Pipe is at ambient temperature (over dew point for cooling). Heating system is cooled down completely.



Ambient temperature
: +5 °C to 40°C



Safety regulations
Clear local safety regulations.



Windy conditions
No windy conditions.



Clean
Clean working environment.



Ventilation
When working in confined space ventilation must be provided.

IMPORTANT!

An insulated system may only be used 24 hours after the work has been carried out and the ThermaGlue is at full strength.

6.2. Installation steps

Pipes and circular ducts

The following instructions are recommendations and may vary with different pipe materials and fittings.

1. Insulate bends & T-pieces

- Install the insulation on the Bends and T-pieces.

TIP!

For tubular insulation connections, end pieces can be made longer to speed things up!

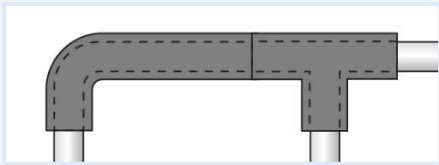

2. Insulate straight length & remaining items

- Insulate straight lengths.
- Insulate remaining pipework / ventilation system elements such as reducers.

Important!

Allow excess length for thermal expansion / contraction at joints to ensure compression joining.

1.

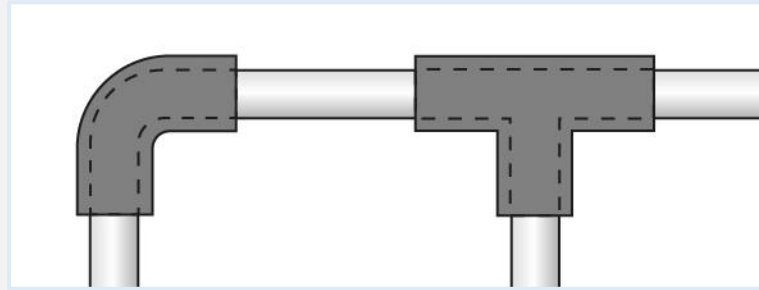

2.

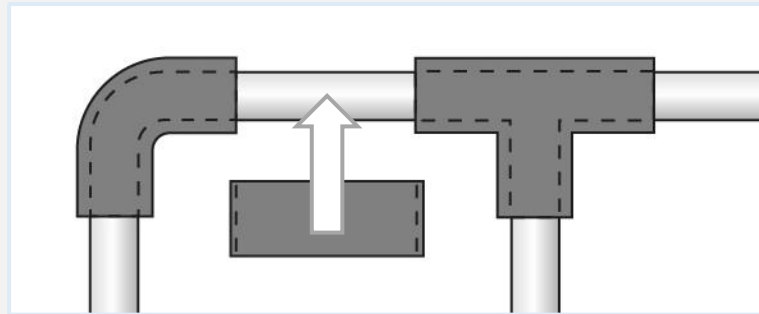

Oversized fitting insulation

The following instructions are recommendations and may vary with different pipe materials and fittings.

1. Insulate straight lengths

- Insulate all straight lengths between fittings.
- Apply compression joining towards fittings and ensure compartmentation.

2. Insulate fittings cover

- Prepare oversized fitting insulation.
- Cut open insulation cover and rejoin over the fitting.
- Use the wet sealing technique to join the insulation fitting cover towards the straight length insulation.

t Wall thickness ThermaSmart Pro insulation material

Important!

Overlap should be > 20 mm and at least the same wall thickness (t).
Use same insulation thickness for the cover.

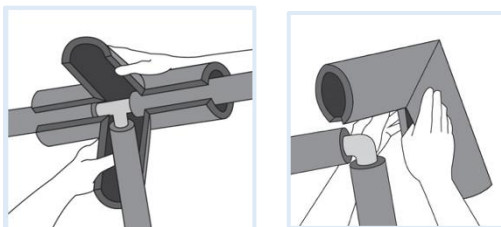

1.

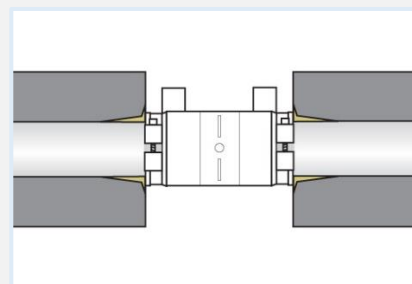

2.

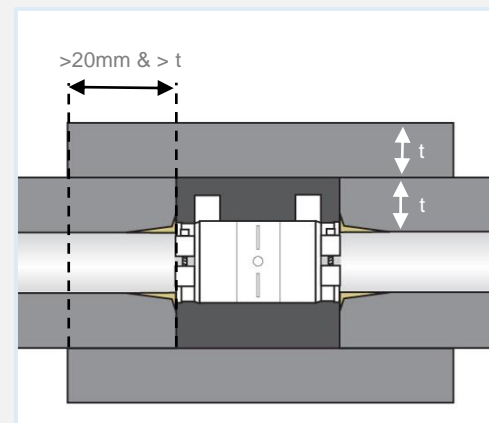
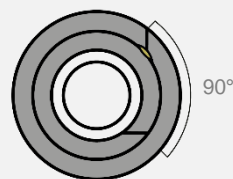

6.3. Golden rules

When installing professional high-quality foam insulation material, the goal is to secure a hermetically sealed system to prevent condensation, water vapor permeation and energy loss.

1. Shut down system

- Never insulate systems that are in operation.
- Start systems at least 24 hours after the last glue is applied so it is fully cured.

2. Good quality tools:

- The right and sharp knives
- Suitable brush

See chapter: Tools

3. ThermaGlue fresh & well mixed

- Check the expiration date and ambient condition of the ThermaGlue.
- Make sure that the ThermaGlue is well mixed at all times!
- At lower temperatures, place in a bucket of warm water for easier application.
- Use small cans to avoid thickening. Refill from larger cans and keep closed when not in use!

4. Maximize joining surface

- Increase the joining surface as much as possible in order to reach the most secure connection possible. It is also makes joining easier.

1.



2.



3.



4.

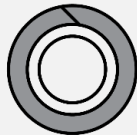

5. Compression joining

- Always allow excess length for butt joints and large surface joining. This is necessary for the thermal expansion / contraction caused by temperature differences in the system.
- Always push the glued joints together, never pull glued joints!

6. Hermetically sealed system

- Make sure the insulation is 100% sealed at the seams so no air can enter in between the insulation and the pipe / duct.

7. Check & Show your work

- All your work (seams) should be visible. At least until the final inspection and after the glue has reached final strength.

5.



6.

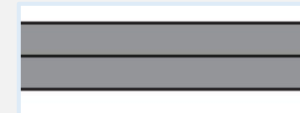

7.

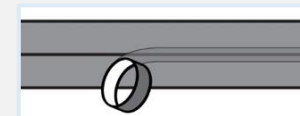
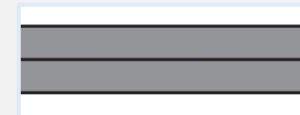

6.4. Measurement & Marking

High quality and clean tools are a precondition for professional insulation work. We offer and recommend a wide range of tools for effectively measuring diameters, lengths, angle. For more assortment details, see the Tools section of this installation manual.

Measurement

Measure circumference for sheet application

When dealing with pipes or circular ducts with a diameter of more than 114mm, use sheet insulation. When applying sheet insulation, avoid tension at all costs. To guarantee measuring the required excess length, we recommend using a strip of insulation of the same thickness to determine the circumference including excess length.

IMPORTANT!

Do not stretch the strip!

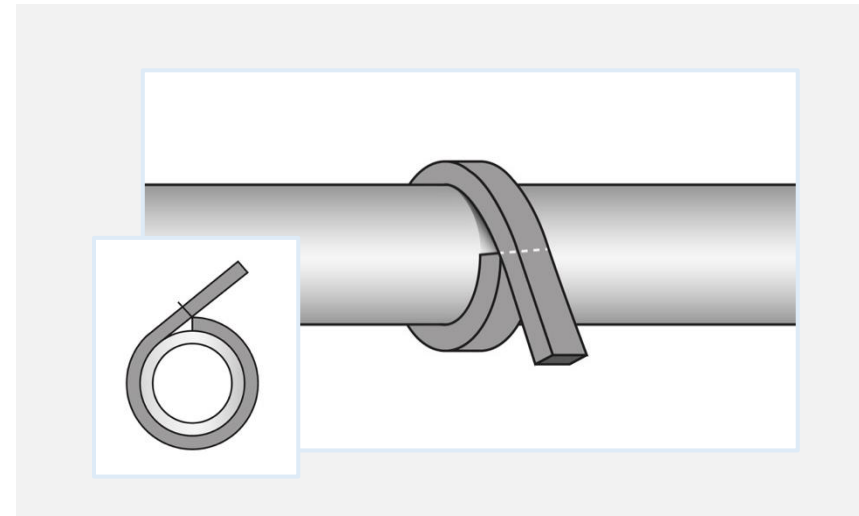

Required tools:



Marking

Marker

For marking we recommend the following:

- Black permanent marker
- White permanent marker

Compass

For circles marking we recommend using a compass or a Talmeter for larger circles.

IMPORTANT!

When marking with a compass, make sure to hold it at a skewed angle as to not to damage the surface. Mark only the necessary parts on the sheet.

Talmeter

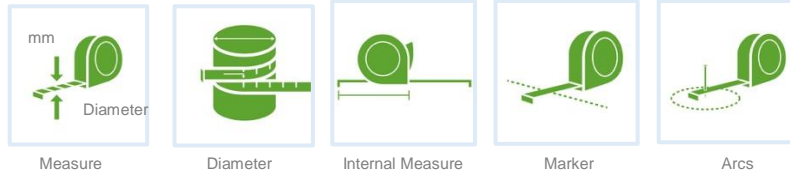

Measure

Diameter

Internal Measure

Marker

Arcs

IMPORTANT!

Before drawing, make sure the corners of the insulation sheet are 90° angles and that the bending of the sheet follows the direction of the object to be insulated.



TIP!

Use the Thermaflex cutting mat for marking rectangular guidelines!

6.5. Cutting

The quality and angle of the cut has an enormous influence on the quality of material bonding. Make sure to use the right knives and cutters with sharp blades. Due to its stability, ThermaSmart PRO provides optimal conditions for clean and easy cuts even with large diameter tubular insulation and guarantee the knife stays sharp for longer. For more details about cutting tools, see the Tools section of this installation manual.

Knives

Cutting

- Perform long strokes when cutting, using a knife with a long and stiff blade.
- Don't put too much pressure on the knife. Let the blade do the work to ensure a clean cut.

Sharpening

We recommend using a whetstone for sharpening the blade.



IMPORTANT!

A sharp knife is essential for high quality cuts and work progress!

Make sure to use the right knife for the right job!

Miter cutting

Cutting mat

The Thermaflex cutting mat offers angular lines for high accuracy and easy assembly of bends and T-pieces. You can also find the angles printed on ThermaSmart PRO tube boxes.

- Align tube insulation along the horizontal dotted line.
- Select the required angle and cut through the tube insulation on the selected angular line.

Miter box

Alternatively, you can use the Thermaflex miter box, designed for cutting tube insulation at 22.5°, 30°, 45° and 90° angles. The blade of the knife should cover the entire width of the miter box to get a precise cut.

- Position the tubular insulation in the miter box.
- Select the required angle and cut through the tube insulation in a long stroke.

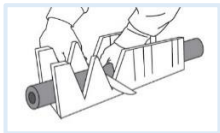

Miter cutter

The miter cutter is used with one blade for 45° beveled cuts and two blades for 90° V-shaped cuts for rectangular ducts.

- When using the miter cutter perform a long pulling movement.
- Exchange blade when necessary.

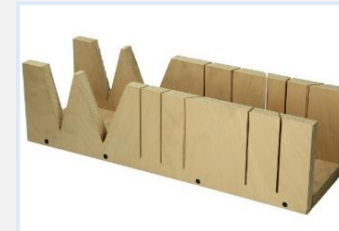
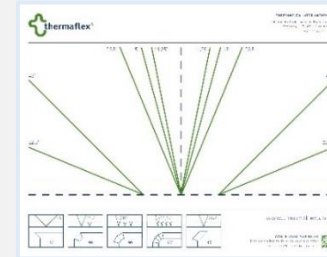
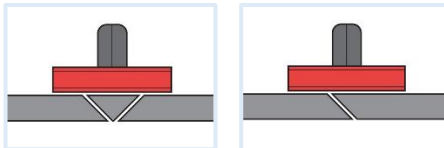

Hole cutting

Hollow punch set

The hollow punches are mainly used for small branching pipes and fixed-point brackets for the threaded rod.

- Select the right pipe diameter.
- Push the hollow punch with light pressure into the insulation material while in a circular motion.



Hollow Punch Set

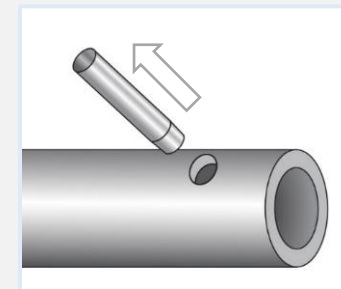
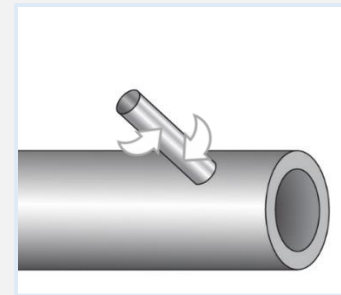
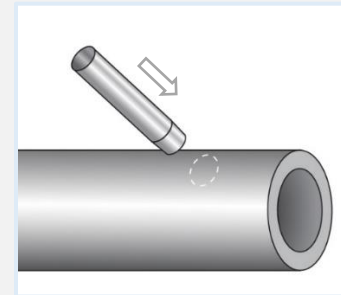

Tube cutting

Cut to length

- Add 2% extra length to compensate for thermal expansion.
- Use the miter box for easier and more precise straight and angular cuts.

Required tools:

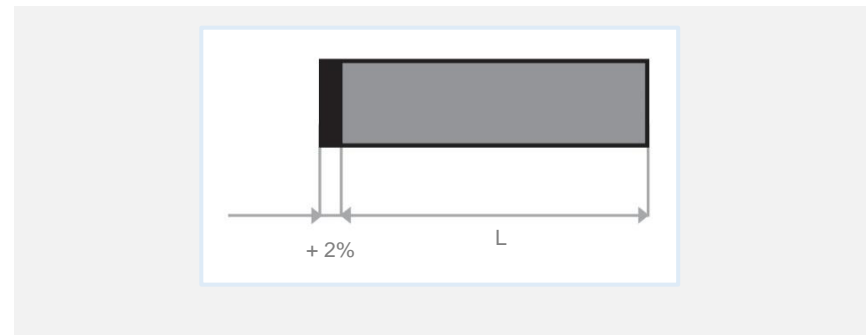
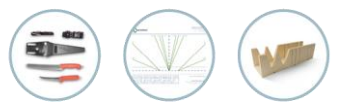

Longitudinal cut

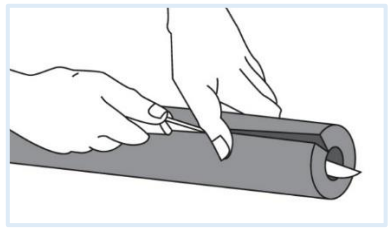

1. Maximize joining surface
 - Make sure to maximize the joining surface as shown in figure 1. for optimum bonding and save, vapor tight joining.
2. Cut on the flat side
 - Always cut tubes on flat side to minimize the tension on the seam.





IMPORTANT!
Reduce the ovality of tube insulation by pressing on it.

Required tools:

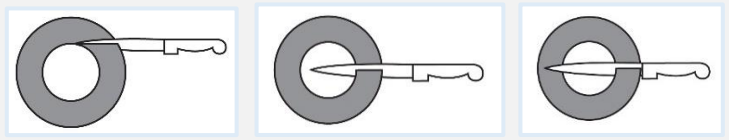

1.   



2.  

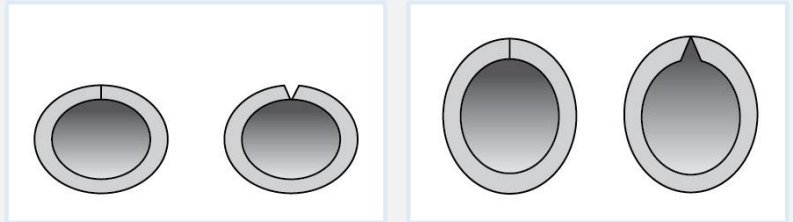

Cut sheet insulation

Rectangular cut

- When cutting sheet insulation, use a knife.

Required tools:



Beveled cut

- Beveled angled cuts are key to increase the joining surface for better bonding during the circumferential joining for pipes, circular ducts and large surfaces.
- When cutting sheet insulation, use a miter cutter or knife for a beveled cut.

Required tools:

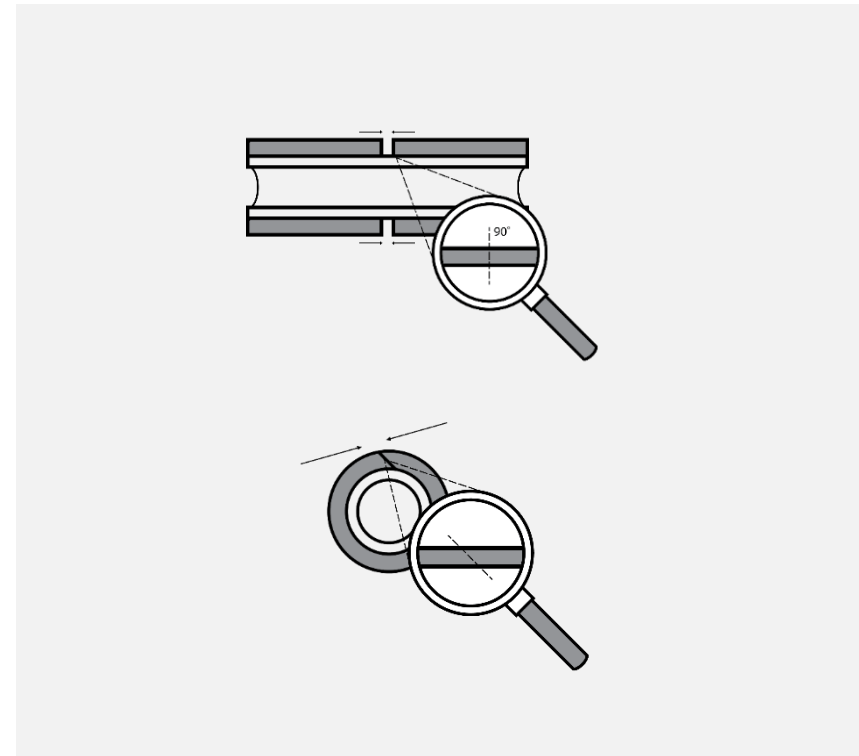

6.6. Cleaning & Surface preparation

ThermaSmart PRO insulation material should be clean and preferably only unpacked just before installation. Just like the insulation material, the object to be insulated must also be clean. When joining surfaces are contaminated by dust, dirt, oil or water, all contaminants need to be removed with Thermaflex cleaner before starting the insulation work. No corrosion should be visible on the object after cleaning for optimum bonding.

Object surface preparation

Although ThermaSmart PRO products offer high corrosion protection, condensation can happen before and during the installation. Depending on the local climate, we recommend sufficient coating of metal pipes prevent corrosion before the system is insulated.

- We recommend a liquid cleaner for polyolefin materials (PB, PE, PP) and cleaning tissues. When using liquid cleaner make sure to use lint-free tissues such as kitchen roll.
- Check if the cleaner is suitable for the surface and coating.
- Let cleaner dry before applying glue.

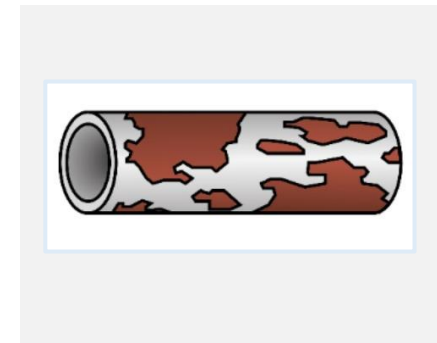

1. Clean object surface

Make sure the material is resistant against the cleaner before cleaning the object surface.

- Object is dry – no moisture
- No corrosion is visible.
- Coating is not damaged.
- Temperature – system is not in operation.



2. Insulation surface

For surface bonding the surface of the insulation material must be cleaned with the recommended cleaner. This ensures optimal bonding between object and insulation. This is also true for joining insulation materials to each other.

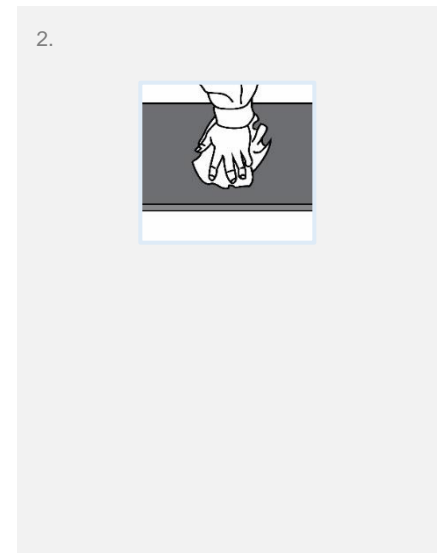

6.7. Gluing -ThermaGlue

For gluing ThermaSmart PRO insulation, we recommend our ThermaGlue only as it is specifically developed for Thermaflex polyolefin materials for best gluing performance. Please read the information on the cans before usage.

Gluing

1. Coating tools

- For applying glue, we recommend using a brush with short, sturdy bristles or Thermaflex Gluemaster.
- For larger areas, use a spatula or Spraygun equipment.

2. ThermaGlue

- Do not apply below 5°C.
- Stir the glue well before usage. Leave 5 min for solids to dissolve and mix well.
- Mix the glue regularly throughout insulation work. If the viscosity is too high, replace with a fresh can.
- Do not dilute glue under any circumstances!
- Keep closed as much as possible.
- Glue reaches final full strength after 24h.

For more details see product label, technical or safety datasheet.

TIP!

- When working at lower temperatures place can into a water bath.
- Use sealable plastic cups for installation to avoid evaporation.

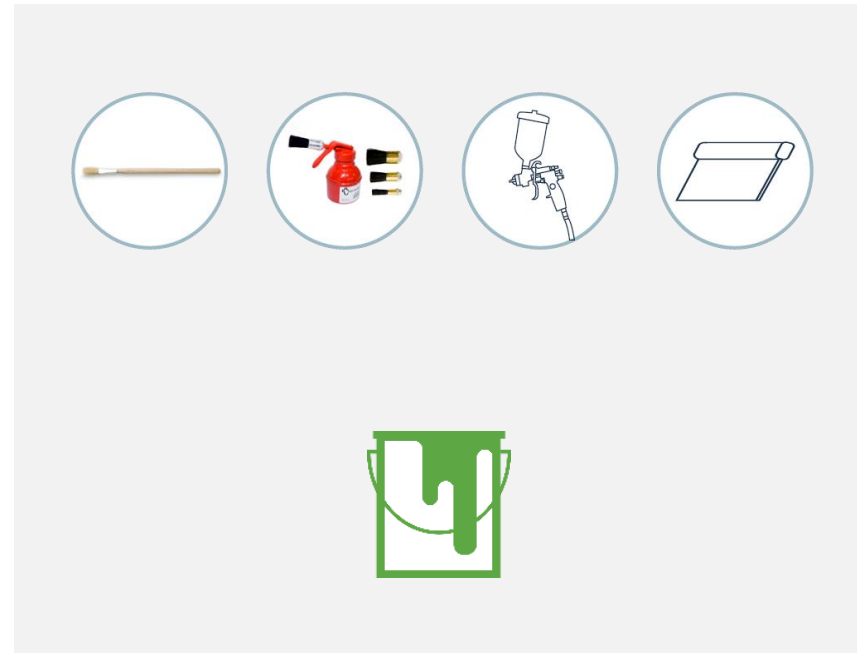

Joining surface preparation

When gluing a cut surface onto an insulation outer surface we recommend surface treatment to improve bonding.

1. Open the cells of insulation outer surface

- Mark the joining surface as shown in the T-piece example in figure 1.
- Open the cells of the outer surface with a knife, by scraping it, or by using emery cloth.
- Clean the surface before joining.

1.

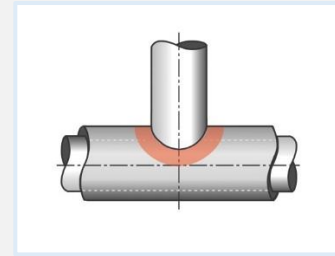

Joining process

ThermaGlue is a solvent-based contact adhesive which bonds best after the solvent has evaporated.

1. Apply ThemaGlue

- Apply a thin and even layer of Thermaflex adhesive on both joining surfaces.
- It is important to cover the entire joining surface area with an even layer of glue.
- Remove all surplus glue.
- When using two different materials apply the adhesive to the insulation material first.

Tip!

When joining onto an object (e.g. metal duct), apply glue to the insulation material first, and then to the object.

2. Let adhesive dry

- Wait until the ThermaGlue is tack dry.
- Use the fingernail test as shown in figure 2.

Important!

The time for the adhesive to become tack-dry depends on the ambient temperature and humidity. Do not try to accelerate the drying process by blowing! Avoid windy conditions!



1.

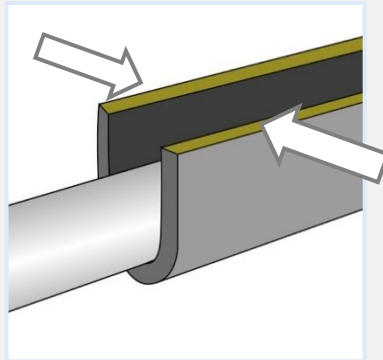

2.

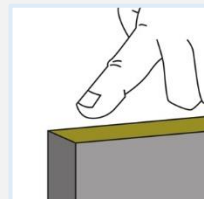
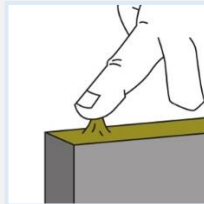

3. Join

- Join the two surfaces using light pressure.

Important!

Do not stretch the insulation material.

Outdoor: Don't expose the joint to direct sunlight after joining!

4. Curing time

- ThermaGlue reaches full strength after a curing time of 24 hours.

3.

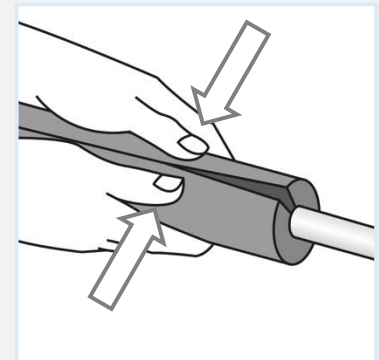

4.



24 hours

Wet sealing technique

The wet sealing technique is used to seal seams under pressure but also to make alterations after the joining surfaces are glued together. This technique should only be used when joining seams under pressure. Wet sealing techniques should also be used for sealing under high temperatures and in draughty and humid areas, as a film layer forms on the sealed surface, which prevents the use of dry sealing techniques. Drying time need not be considered for this method as the joining surfaces can be joined immediately.

Tube (butt joints)

1. Apply ThernaGlue

- Pull the compressed butt joints apart.
- Apply adhesive evenly between the both joining surfaces.

2. Join

- Use light pressure to join the two insulation tubes together for a vapor tight bond.

Important!

Add +2% excess length to compensate for thermal expansion.

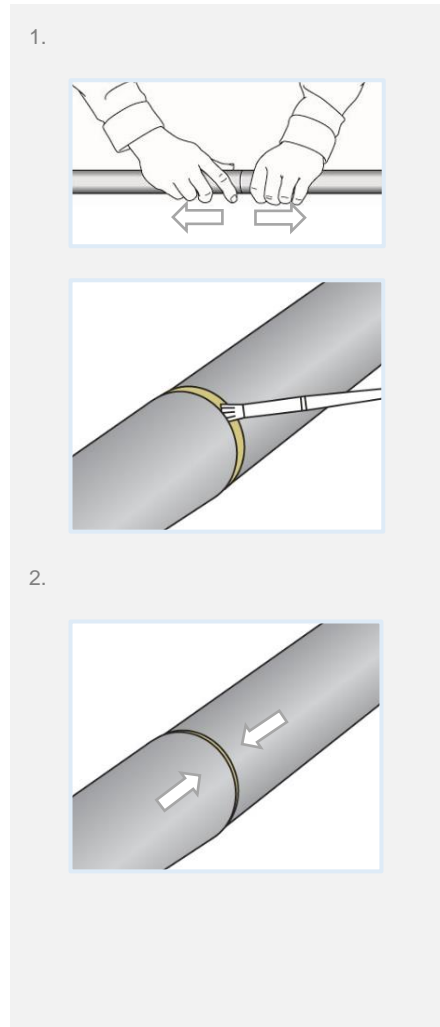

Sheet

1. Apply sheet insulaton

- Apply sheet with an excess length of +5mm onto the object for compression joining.
- When joining the sheet material onto the object, don't apply glue at the last 30 - 50mm.

2. Apply ThernaGlue

- Lift the part that's not yet glued and apply adhesive evenly on the bottom of the sheet and the butt joint on all joining surfaces.

3. Join

- Press the sheet insulation onto the object and onto the existing sheet as shown in figure 3.
- The joining happens immediately after the glue is applied and still wet.
- Check after 15 min and apply light pressure onto the joined surfaces if required.

Important!

Add +5mm excess length to compensate of thermal expansion.

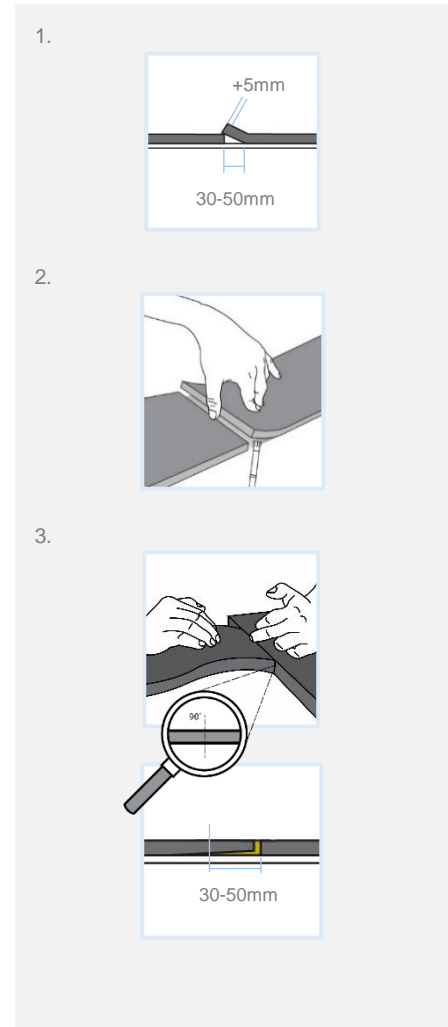

Vapor-tight hermetic sealed system

To guarantee high and hassle-free system performance for chilled water installations without condensation headaches, securing a fully watertight and vapor-tight insulation system is key.

1. Hermetically sealed

After finishing insulation works, all seams must be checked.

- If a seam is not fully sealed, apply glue to the seam using a brush.
- Let glue dry and press together to tighten the seam.

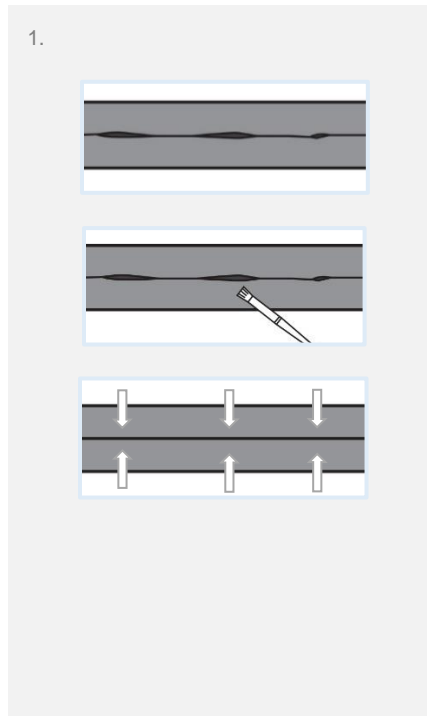

2. Hollow space

Hollow spaces between the insulation and the pipework is allowed when the insulation system is hermetically sealed.

Important!

For heavy duty cooling we recommend avoiding hollow spaces.

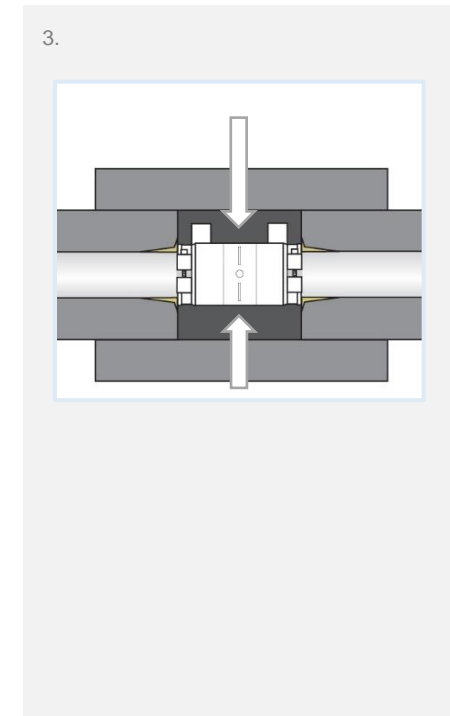

Large surface Insulation

For big pipe diameter, circular and rectangular ducts, tanks, vessels and other large objects, use ThermaSmart PRO sheet insulation.

Surface insulation

- Join the first sheet (1) toward the object.
- Continue in one direction when joining the second (2) sheet onto the object.
- Use wet sealing technique to make a vapor-tight bond between the two sheets.
- Continue according the layout of the sheet segments as shown in figure 1.

Important!

Always allow additional 5mm extra length and don't apply glue on the last 30-50mm of the sheet for wet sealing.

Tip!

For fast & efficient insulation work, prepare an insulation layout for your large object like shown in figure 1.

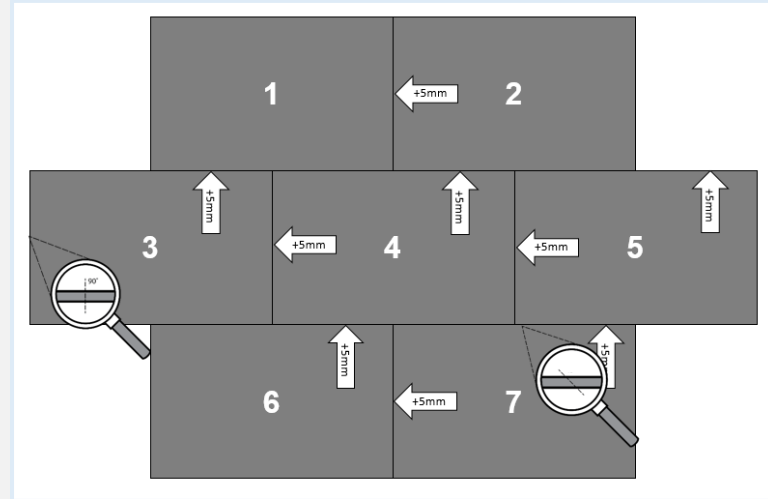

Multi-layer Insulation

The multi-layer-technique is used when higher thicknesses are needed or to reduce tension in the material or seams. This technique uses smaller wall thicknesses, but more layers of insulation. The technique is used with ThermaSmart PRO tubes and sheet insulation, and can be used in combination with any object.

1. Surface insulation

- Join the first layer to the object.
- The second layer should be joined onto the first layer at least at seam level and at the ends of the sheet material to prevent sacking. The gluing layout (where to place glue) depends on the application. See relevant manual.
- The second and any additional layer should be applied in the same manner and the seams of the different layers must not align above each other.

2. Pipes and circular ducts

- After applying the first layer, the second layer should be applied in the same manner.
- Ensure that the two layers are at least 90° away from each other and that the longitudinal seam don't overlap as shown in figure 2.
- Apply glue below the seam of the 2nd layer.

1.

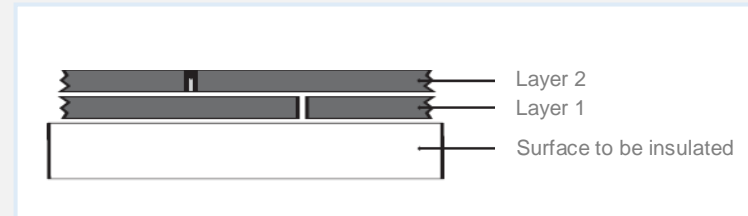

2.

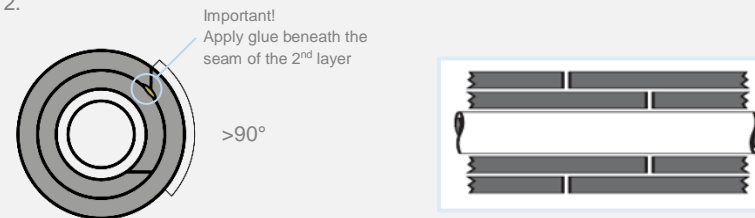

Compartmentation

To avoid the distribution of fluid under the insulation that can occur due to leaking carrier pipe or condensation due to damaged insulation (not hermetically sealed system), working with compartments is a must. The additional advantage of compartments is that allows to quickly locate such problem areas, especially with leaky carrier pipes.

1. General

- Compartmentation is recommended at least every 2m.
- This also applies to each sealed seam when fitting the material.
- For ThermaSmartPRO sheet insulation, compartmentation is done automatically during the installation process.

2. Tubular insulation

- With tube insulation, the tube should be glued to the carrier pipe on each end.
- Apply glue around the pipe with a width of at least 2 cm, and of at least the wall thickness of the insulation.

t Wall thickness ThermaSmart Pro insulation material

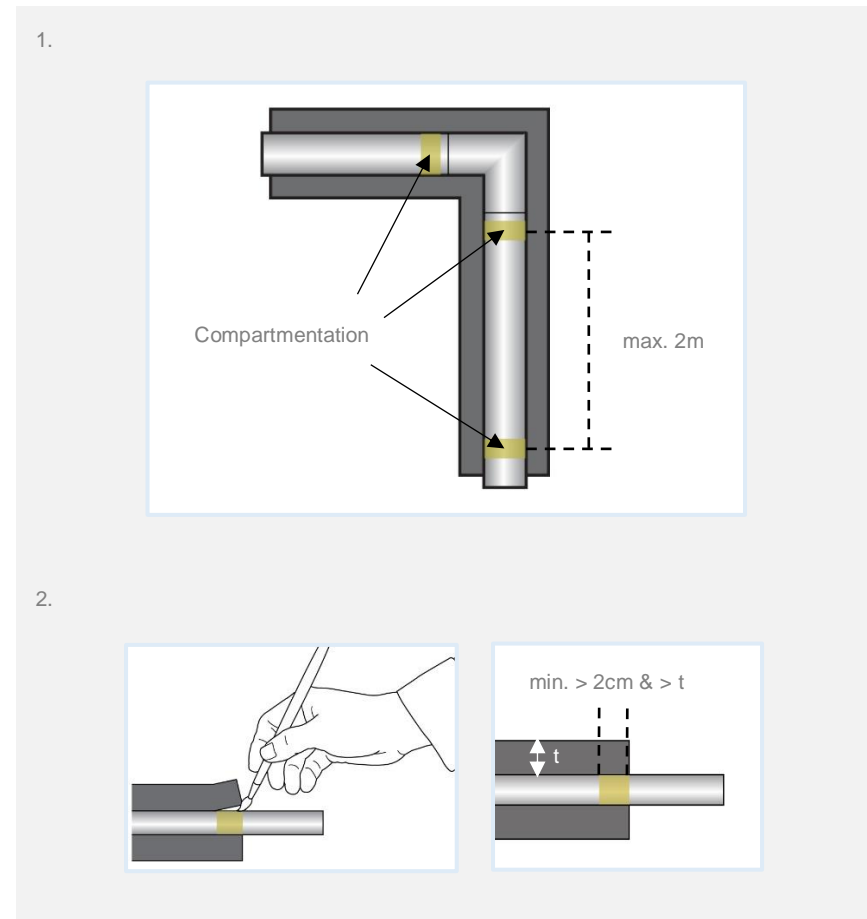

Extreme installation conditions

Hot and humid climates

When working in high temperature environment the solvent in the ThermaGlue evaporates faster and moisture may occur on the surface of the adhesive. This influence the reliability of joints.

We recommend the following:

- Instead of the normal joining technique, use the wet sealing technique (join surfaces while the glue is still wet). The joining surfaces should be held together whilst wet.
- To prevent possible tension within the material and on the seam, the seams should be held together with strips of insulation glued crosswise every 20 cm.
- Alternatively, self-adhesive insulation tape (ThermaTape) can be used instead. General, we recommend ThermaTape for aesthetic reasons only. Leave the tape onto the seam until after the curing process.

IMPORTANT!

Due to the fast drying and curing time, the glue should be applied only to a limited area of the joining surface!

1.

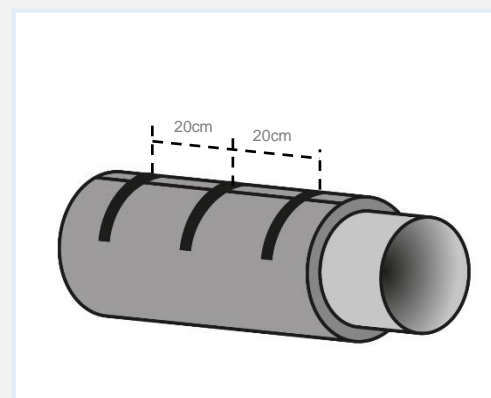

07. Accessories

Pipe support

Thermaflex Pipehanger

For a vapor-tight system

For chilled water applications, pre-insulated pipe supports are recommended to create a fully watertight and vapor-tight system. When opting for alternative pipe hangers, it is difficult to ensure that the clamp will be vapor-tight when used in combination with Thermaflex insulation.

Our pre-insulated hangers prevent:

- Condensation gaps
- Thickness compression of insulation
- Undesirable influence on the system performance of chilled water applications.

Hereby ensuring an optimal, and hassle-free system performance.

TIP!

- Use a nylon locking nut / anti-vibratory fastener.
- Apply non-skid pads to the clamps to minimize movement.
- Keep in mind pre-insulated hangers should be installed together with the pipes.

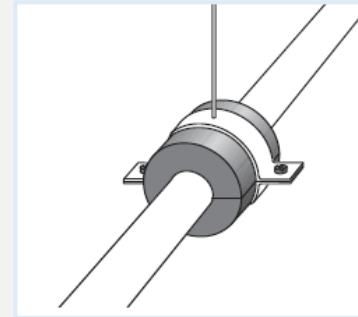

Thermaflex Pipehanger

1. Place insulation block

Wrap the insulation block around the pipe.

1.

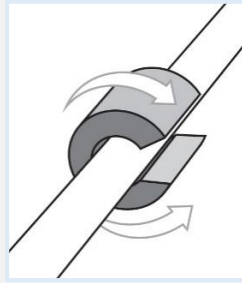

2. Seal insulation block

Seal the block with the self-adhesive strip or tape (depending on the product).

2.

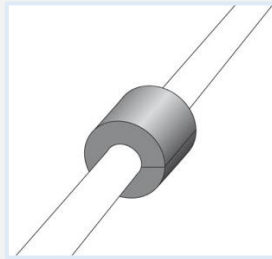

3. Place pipe hanger clamp

Place the pipe hanger clamp on the insulation block.

3.

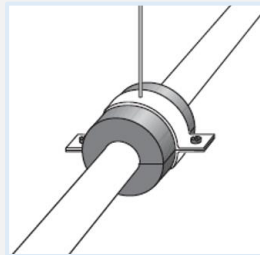

4. Coat with glue

Coat all joining surfaces of the pipe hanger and insulation tube with glue.

4.

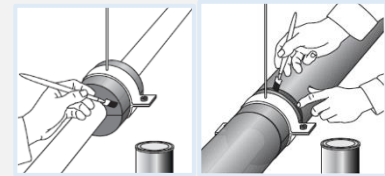

5. Let glue sit and join

Let glue sit until tack dry (fingernail test) and firmly press the insulation against the pipe hanger insulation block.

5.

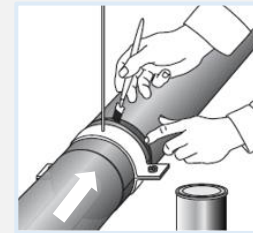

6. Heavy duty cooling

For heavy duty cooling installations, it is recommended to insulate the seams with tube or sheet insulation as shown in figure 6.

6.

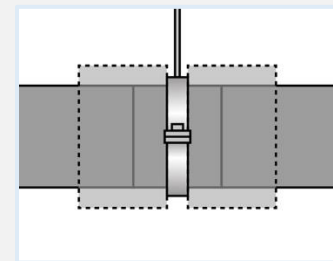

IMPORTANT!

Pipe hangers are not suitable for anchoring! (sliding brackets)

Insulating Fixed point brackets

In case you're dealing with fixed points and readily installed pipe clamps, we recommend the following solution.

1. Mount bracket & pipe

- Insulate the pipe as close as possible to the fixing brackets with tubular or sheet insulation on both sides.
- When the insulation thickness is bigger than that of the pipe clamp, seal in the complete clamp and glue together the two pipe ends.

2. Compartmentation

- Seal the ends of the tubular insulation to the pipe with ThermaGlue .

3. Insulation cover

- Depending on the diameter, either use ThermaSmart PRO tubes or sheet for the insulation cover. Cut out a small hole for the threaded rod and slit it to fit over the pipe clamp as shown in figure 3.
- Make sure that the insulation overlap from the cover and the pipe insulation is > 20mm and at least the insulation wall thickness.
- Place the insulation cover over the fixing bracket and cut the actual required circumference.

Important!

Use tubular / sheet insulation material with the same insulation thickness.

1

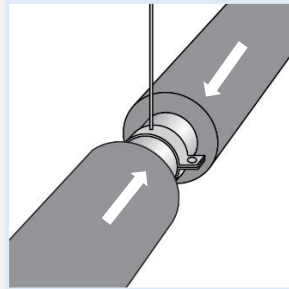

2.

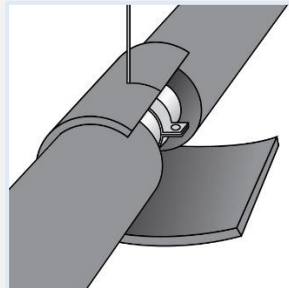

3. Join

- Join the closure.
- Use wet sealing technique to join the insulation cover onto the pipe insulation.

Important!

Don't forget to clean and scrape the joining surfaces!

3.

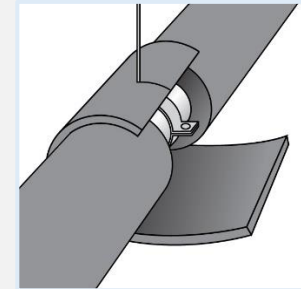

4.

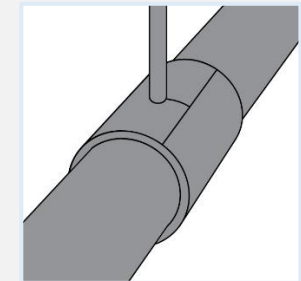

4. Insulate rod

- Insulate the threaded rod and join onto the insulation cover to avoid condensation on the rod!

REMARK:

Making this part vapor-tight highly depend on which fixing bracket system is used.

Adhesive

Polyolefin Surface Cleaner

For optimal bonding between the ThermaSmart PRO foam insulation material and the pipe, duct or other objects as well as between the material itself, a suitable cleaner must be used. We recommend a regular liquid cleaner for polyolefin materials (PB, PE, PP). Make sure that the surface to be insulated is resistant against the cleaner.

We offer a perfectly suitable cleaner for polyolefin materials.

ThermaGlue

ThermaGlue is packaged in 0.25l, 1.0l and 20l cans. Gluing the cut edges is an equally important step in installation since it directly affects the durability of the system and hassle-free operation. Thermaflex glues dry quickly and makes a perfect bond between the two edges. Once dry, they also exhibit self-extinguishing properties. The adhesive is characterized by its ease of use, high yield and the soft, durable bonds it creates. It can also be sprayed.

Safety:

- The glue and solvents are volatile substances that may carry health hazards in high concentration.
- When working in confined spaces, ventilation must be provided.

Product features:

- Application temperature > +5°C to +40°C (> 15°C for guaranteed optimal adhesion)
- Time until the glue is tack-dry depends pretty much on ambient temperature and humidity
- Curing time / maximum final strength after 24 hours
- Average consumption: 4m² per 1 liter (both sides covered)
- Flammable
- Temperature resistance -20°C to +95°C (reliable and safe joining)
- Storage and transport temperature max. +35°C
- Shelf-life 12 months in unopened



Foam insulation accessories

Prefabricated Parts

Built for speed

ThermaSmart PRO elbows and tees bring you fast, professional results on pipe bends, branches and other places where insulation is difficult to install. Prefabricated to provide easy and efficient assembly, they reduce the number of thermal bridges to ensure maximum system efficiency at minimal operational cost.

For custom-built solutions, please contact your Thermaflex contact. We are more than happy to speed up your project!



ThermaTape

Polish your ductwork

The ThermaSmart PRO insulation tape is a self-adhesive insulation strip with a width of 50mm and a 3mm insulation thickness. For professional insulation works in general, an additional use of self-adhesive ThermaSmart PRO tape is not necessary after joining. We recommend the usage of our foam insulation tape for professional insulation works for optical reasons in ductworks only. If needed, apply the ThermaTape only after a curing time of 24 hours.



08. Tools

The following tools have been tailor-made for the installation of ThermaSmart PRO sheet insulation, and ensure sustainable functionality and convenience for insulators around the world working with our material. We therefore highly recommend to work with our PRO toolbox, available for purchase from your local dealer. Make sure our tools comply with your national laws and safety standards for building sites.

Knives & cutters

Specialized 25cm, and 12.5cm insulation knife set

For serious insulation functionality.

The double insulation knife set has been developed for fast, efficient and comfortable cutting and shaping of ThermaSmart PRO insulation. The 2 knives are accompanied by a locking safety holster, belt and lanyard to ensure maximum safety, and convenient transportation.



Small paring knife, 8cm

For the finer craft.

The 8cm straight-edge paring knife is for the finer cuts and shapes. Its pointed head makes it ideal for carving, cutting, and shaping for detail and accuracy.



Utility knife

The all-rounder.

Our universal utility knife is a safe companion when you're on the move. Its long, stable 40mm blade retracts automatically upon release, ensuring maximum safety. Are you a left hander? Simply open the handle, and turn the blade around – no tools needed. Comes with belt holster for easy transportation.



Miter cutter

Angle for perfection.

The miter cutter is suited for insulation applications with 90° angles, such as ventilation channels. With its 45° angled blades, it can perfect V-grooves in your insulation sheet in one smooth pull. The miter cutter is also suited for 45° beveled cuts of sheet insulation for better joining. The maximum insulation thickness possible is 13mm. An additional blade set is included.



Hollow punch set (5pcs)

For the perfect circle.

Our universal stainless steel hollow punches are ideal for quickly, and efficiently carving out pipe ends. The 5-piece set covers the standard, most commonly applied diameters: 21mm, 27mm, 33mm, 38mm, and 60mm.



Whetstone

Keep it sharp.

A sharpening stone is included to keep your knives razor-sharp, and ensure the best and smoothest possible cuts.



Measurement & marking

Talmeter (3m)

Measure it. Mark it. Craft it.

The ideal marking measure for insulation craftsmen. This white, impact-resistant steel tape measure has both millimeters and diameters, combining marking and measurement edges so you can quickly and simply measure and mark both internal and external lengths. Superior for marking large diameters.

Outside calipers

Who goes around, knows around.

Need to figure out your exact pipe diameter? Our outside calipers are the perfect way to do so. Just clip them round, and measure the span.

Compass

Mark like a pro.

Our nickel-plated steel compass is accurate and fast adjusting, and marks circles up to 107cm. Points can be easily re-sharpened or replaced.

Cutting mat

Cut to fit.

Use our Thermaflex-designed cutting mat for optimal angular precision, covering all the cutting angles you need. Perfectly suitable for all your elbows, bends, T and Y pieces, you name it. The cutting mat is made for both right and left handed craftsmen.

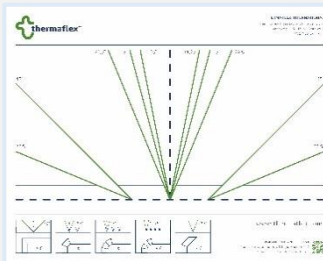

Folding ruler

Unfolding precision.

Our folding ruler measures length and angular degrees all in one handy, compact tool.

Metal ruler (50cm)

Solid precision.

Our metal ruler measures cm and inch.

Marker

Swift and sure.

Draw out exactly where you need to cut, shape, or carve with our black insulation marker.

Miter box (optional)

Cut to fit.

Use the miter box for optimal angular precision, covering all the cutting angles you need. Perfectly suitable for all your elbows, bends, T and Y pieces, you name it.

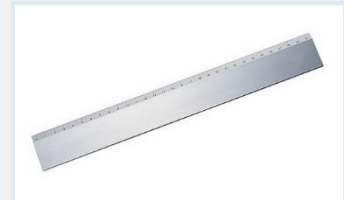

Adhesive Tools

Glue master

Solidity is key.

The 0,25l glue master allows for a quick, and efficient application of our specially developed Thermaflex adhesive. Our selection of 3 detachable brushes including a 11mm, 17mm and 23mm brush, makes it applicable for medium and larger surface areas.



Spare brushes

For superb application.

Glue master replacement parts. Our selection of 3 detachable brushes including a 11mm, 17mm and 23mm brush, makes it applicable for medium and larger surface areas.



Brush

For the delicate work.

To perfect the small and narrow gluing work, our professional glue brush is your best bet.

TIP!

We recommend a flat brush with sturdy and short bristles.



Polyfusion welding

Butt welding unit

For solid and homogenous joining.

Butt welding unit for polyolefin insulation with PTFE-coated heating element 230V, 50-60Hz according to DVS. Available with 110V. Temperature preset for polyfusion welding of ThermaSmart PRO tubular insulation at 180°C. Heating element \varnothing 200 mm and \varnothing 300 mm. Support stand.



Optional Tools

The following tools are relatively standard, but also recommended. As they tend to be already widely included in standard insulation toolkits, we do not include them in our PRO toolbox, and can be easily acquired locally.

Knives & cutters

Long Knife (30cm)

For professional insulation works.

A 30cm long and thin blade allows for perfect beveled cuts and easy working in combination with the Thermaflex Miter Box.



Cutting aid

For perfect beveled cutting.

Use a cutting aid with 130cm length for long, perfect 45° beveled cuts with sheet insulation.

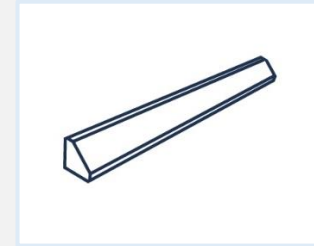

Measurement & marking

Steel framing square

Angular precision.

Use a steel framing square for perfect 90° precision marking on sheet insulation.

TIP!

Use the Thermaflex cutting mat instead!

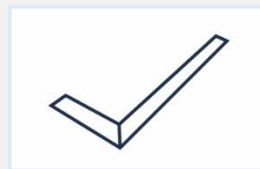

Adhesive Tools - large surfaces

Spray glue gun

Rapid application.

A spray gun offers rapid application of Thermaflex adhesive for large surfaces.

TIP!

Contact your Thermaflex partner to get information on the required specifications!

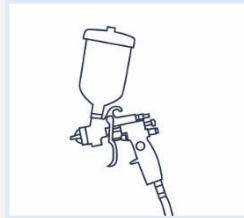

Glue roller

Fast application.

A glue roller ensures rapid application of Thermaflex glue to bigger surfaces.



Spatula

Fast application.

A smooth spatula ensures rapid application of Thermaflex glue. Suitable for bigger surfaces.

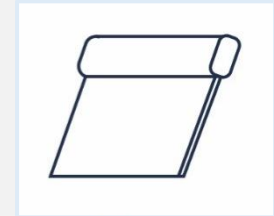



WWW.THERMAFLEX.COM



Installation video's.

Thermaflex International Holding b.v.
Veerweg 1, 5145 NS Waalwijk
The Netherlands



Installation video's.